

Poly VVX EM50 Expansion Module

Supported with Poly VVX 450 Business IP Phones

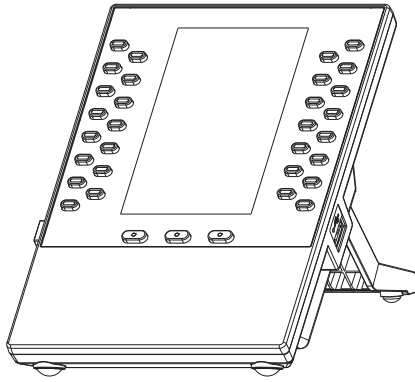

Package Contents

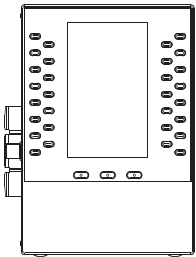

Expansion Module

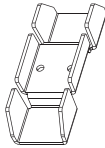

Bracket
(attached)



Screw

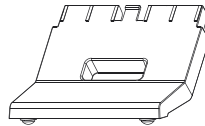

Base Stand

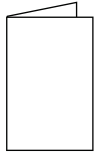

Setup Sheet

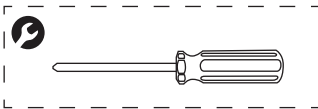

Optional Accesories

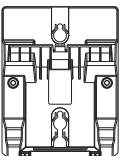

Wall Mount Bracket
(2200-48893-001)

For more information on optional accessories, contact your reseller.

Features

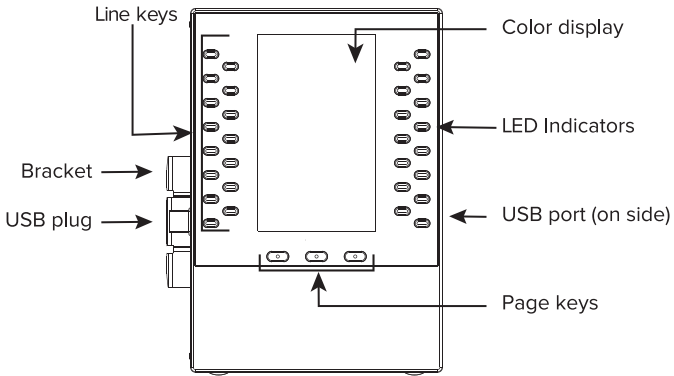

Connect the Base Stand

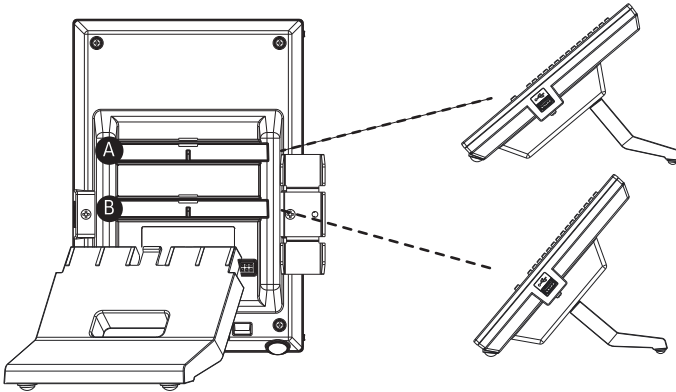

Mount the Expansion Module (Optional)

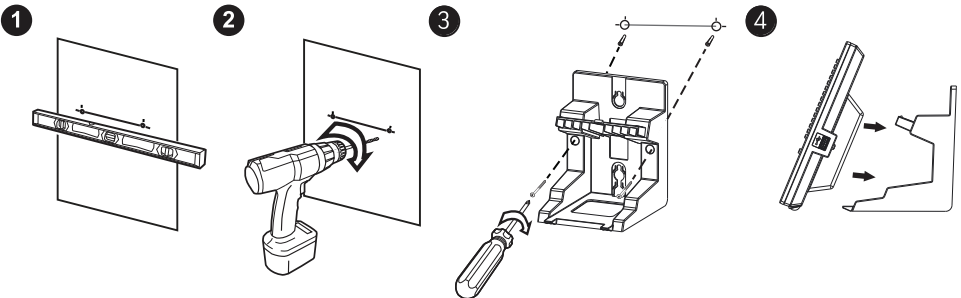
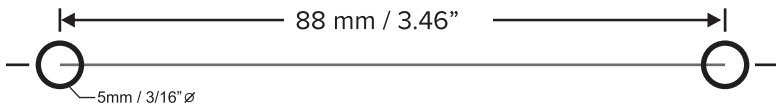

Connect the Expansion Module

Power off the phone before connecting the expansion module.

1

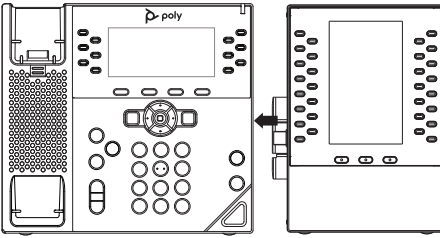

2

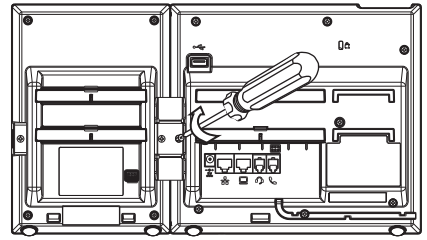

Connect a Second Expansion Module

Power off the phone before connecting an additional expansion module.

1

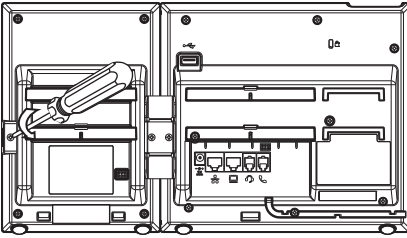

2

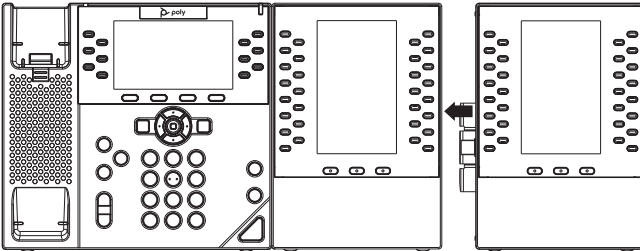

3

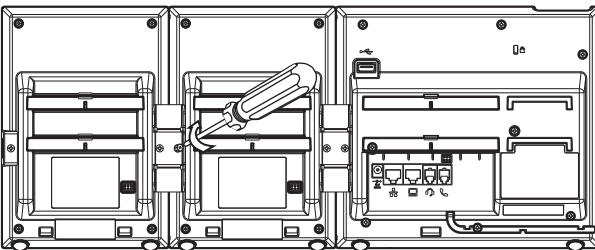

Note: You can connect up to two VVX EM50 expansion modules to a VVX 450 business IP phone.



BY USING THIS PRODUCT, YOU ARE AGREEING TO THE TERMS OF THE END USER LICENSE AGREEMENT (EULA) AT: <http://documents.polycom.com/indexes/licenses>. IF YOU DO NOT AGREE TO THE TERMS OF THE EULA, DO NOT USE THE PRODUCT, AND YOU MAY RETURN IT IN THE ORIGINAL PACKAGING TO THE SELLER FROM WHOM YOU PURCHASED THE PRODUCT.

The Terms and Conditions applicable to Polycom's Limited Warranty for this product are found at http://supportdocs.polycom.com/PolycomService/support/global/documents/support/others/plcm_warranty_summary.pdf

SAFETY AND REGULATORY INFORMATION.

This equipment has been tested and found to comply with the limits for a Class B digital device, pursuant to part 15 of the FCC Rules. These limits are designed to provide reasonable protection against harmful interference in a residential installation. This equipment generates, uses and can radiate radio frequency energy and, if not installed and used in accordance with the instructions, may cause harmful interference to radio communications. However, there is no guarantee that interference will not occur in a particular installation. If this equipment does cause harmful interference to radio or television reception, which can be determined by turning the equipment off and on, the user is encouraged to try to correct the interference by one or more of the following measures:

- Reorient or relocate the receiving antenna.
- Increase the separation between the equipment and receiver.
- Connect the equipment into an outlet on a circuit different from that to which the receiver is connected.

Consult the dealer or an experienced radio/TV technician for help.

Responsible Party issuing FCC Supplier's Declaration of Conformity

Polycom, Inc.
6001 America Center Drive
San Jose, CA
95002
USA
TypeApproval@poly.com

The VVX EM50 is marked with the CE mark. This mark indicates compliance with LVD and EMC Directives 2014/35/EC and 2014/30/EC. A full copy of the Declaration Of Conformity can be obtained from Polycom (NL) BV., Scorpions 171, 2132 LR Hoofddorp, NL.

In accordance with Part 15 of the FCC Rules, the user is cautioned that any changes or modifications not expressly approved by Polycom, Inc. could void the user's authority to operate the equipment.

Operating Ambient Conditions:

- Operating temperature: +32 to 104°F (0 to 40°C)
- Relative humidity: 5% to 95%, non-condensing
- Storage temperature: -40 to +160°F (-40 to +70°C)

Installation must be performed in accordance with all relevant national wiring rules.

L'Installation doit être exécutée conformément à tous les règlements nationaux applicables au filage électrique.

When using Power over Ethernet (PoE), the host equipment is to be connected only to PoE networks without connections to the outside plant.

Lorsque vous utilisez une alimentation électrique par câble ethernet (PoE - Power over Ethernet), l'équipement doit être connecté uniquement aux réseaux PoE sans connexions vers l'extérieur de l'usine.

This Class [B] digital apparatus complies with Canadian ICES-003. Cet appareil numérique de la classe [B] sera conforme à la norme NMB-003 du Canada.

To avoid electric shock, do not connect safety extra low voltage (SELV) circuits to teleconference station network (TNV) circuits. LAN ports contain SELV circuit, and WAN ports contain TNV circuits. Some LAN and WAN ports both use RJ-45 connectors. Use

caution when connecting cables on the host equipment. This product is rated 5Vdc, 3A.

Afin d'éviter les chocs électriques, ne pas connecter de circuits de tension extra-basse de sécurité (SELV) à des circuits de réseau de stations de téléconférence (TNV). Les ports LAN contiennent un circuit SELV et les ports WAN contiennent des circuits TNV. Certains ports LAN et WAN utilisent tous deux des connecteurs RJ-45. Faites preuve de prudence lors de la connexion des câbles. Ce produit a les caractéristiques suivantes : 5 Vdc, 3 A.

In addition, all PoE sources must meet the Limited Power Source requirements of IEC 60950-1:2005 (2nd Edition); Am1:2009 or IEC 60950-1:2005 (2nd Edition); Am1:2009; Am2:2013. En outre, toutes les sources PoE doivent satisfaire aux exigences de source d'alimentation limitée de la IEC 60950-1:2005 (2ème édition); Am1:2009 ou IEC 60950-1:2005 (2ème édition); Am1:2009; Am2:2013.

Restriction of Hazardous Substances Directive (RoHS):

Polycom products are fully compliant with the requirements of the EU RoHS Directive 2011/65 EU.

For more information and details of the EU exemptions that are used for this product, please contact TypeApproval@poly.com.

Regulatory Notice:

<https://support.polycom.com/content/dam/polycom-support/products/voice/business-ip-phones/other-documents/en/vvx-ip-regulatory-notice.pdf>

EU WEEE – End of Life products:

Polycom encourages you to recycle your end-of-life Polycom products in an environmentally considerate way. In accordance with the requirements of the European Waste Electronic and Electrical Equipment (WEEE) Directive, all Polycom products are marked with the crossed wheelee bin symbol shown below. Products that carry this symbol should be not be disposed of in the household or general waste stream. Detail of the options open to you and the guidance on the requirements for the recycling and environmentally considerate disposal of your end of life Polycom products can be found at <http://www.polycom.com/WEEE>.

Australia:

Warning—This equipment will be inoperable when mains power fails.

Japan:

この装置は、クラスB機器です。この装置は、住宅環境で使用することを目的としていますが、この装置がラジオやテレビジョン受信機に近接して使用されると、受信障害を引き起こすことがあります。
取扱説明書に従って正しい取り扱いをして下さい。 VCCI — B

Contact Information:

Please contact your Polycom Authorized Reseller for assistance.

<http://www.polycom.com>
Plantronics, Inc. (Poly - formerly Plantronics and Polycom)
345 Encinal Street, Santa Cruz, California 95060

1725-48895-003A

